

### FEATURES

**PSRR: 100 dB minimum**

**CMRR: 105 dB typical**

**Very low supply current: 10  $\mu$ A per amplifier maximum**

**1.8 V to 5 V single-supply or  $\pm 0.9$  V to  $\pm 2.5$  V dual-supply operation**

**Rail-to-rail input and output**

**2.5 mV offset voltage maximum**

**Very low input bias current: 0.5 pA typical**

### APPLICATIONS

**Pressure and position sensors**

**Remote security**

**Medical monitors**

**Battery-powered consumer equipment**

**Hazard detectors**

### GENERAL DESCRIPTION

The ADA4505-2 is a dual micropower amplifier featuring rail-to-rail input and output swings while operating from a 1.8 V to 5 V single or from  $\pm 0.9$  V to  $\pm 2.5$  V dual power supply.

Employing a new circuit technology, this low cost amplifier offers zero input crossover distortion (excellent PSRR and CMRR performance) and very low bias current, while operating with a supply current of less than 10  $\mu$ A per amplifier.

This combination of features makes the ADA4505-2 amplifier an ideal choice for battery-powered applications because it minimizes errors due to power supply voltage variations over the lifetime of the battery, and maintains high CMRR even for a rail-to-rail op amp.

### PIN CONFIGURATION



Figure 1. 8-Lead MSOP (RM-8)

Remote battery-powered sensors, handheld instrumentation and consumer equipment, hazard detectors (for example, smoke, fire, and gas), and patient monitors can benefit from the features of the ADA4505-2 amplifier.

The ADA4505-2 is specified for both the industrial temperature range ( $-40^{\circ}\text{C}$  to  $+85^{\circ}\text{C}$ ) and the extended industrial temperature range ( $-40^{\circ}\text{C}$  to  $+125^{\circ}\text{C}$ ). The ADA4505-2 dual amplifiers are available in the standard 8-lead MSOP package.

The ADA4505-2 is a member of a growing series of zero crossover op amps offered by Analog Devices, Inc., including the AD8506, which also operates from a 1.8 V to 5 V single or from  $\pm 0.9$  V to  $\pm 2.5$  V dual power supply.

#### Rev. 0

Information furnished by Analog Devices is believed to be accurate and reliable. However, no responsibility is assumed by Analog Devices for its use, nor for any infringements of patents or other rights of third parties that may result from its use. Specifications subject to change without notice. No license is granted by implication or otherwise under any patent or patent rights of Analog Devices. Trademarks and registered trademarks are the property of their respective owners.

## TABLE OF CONTENTS

Features .....	1	ESD Caution.....	5
Applications.....	1	Typical Performance Characteristics .....	6
Pin Configuration.....	1	Theory of Operation .....	14
General Description .....	1	Applications Information .....	16
Revision History .....	2	Pulse Oximeter Current Source .....	16
Specifications.....	3	Four-Pole Low-Pass Butterworth Filter for Glucose Monitor.....	17
Electrical Characteristics—5 V Operation.....	3	Outline Dimensions .....	18
Electrical Characteristics—1.8 V Operation .....	4	Ordering Guide .....	18
Absolute Maximum Ratings.....	5		
Thermal Resistance .....	5		

## REVISION HISTORY

7/08—Revision 0: Initial Version

# SPECIFICATIONS

## ELECTRICAL CHARACTERISTICS—5 V OPERATION

$V_{SY} = 5\text{ V}$ ,  $V_{CM} = V_{SY}/2$ ,  $T_A = 25^\circ\text{C}$ , unless otherwise specified.

Table 1.

Parameter	Symbol	Conditions	Min	Typ	Max	Unit
<b>INPUT CHARACTERISTICS</b>						
Offset Voltage	$V_{OS}$	$0\text{ V} \leq V_{CM} \leq 5\text{ V}$ $-40^\circ\text{C} \leq T_A \leq +125^\circ\text{C}$		0.5	2.5	mV
Input Bias Current	$I_B$	$-40^\circ\text{C} \leq T_A \leq +85^\circ\text{C}$		0.5	2	pA
		$-40^\circ\text{C} \leq T_A \leq +125^\circ\text{C}$			50	pA
Input Offset Current	$I_{OS}$	$-40^\circ\text{C} \leq T_A \leq +125^\circ\text{C}$			300	pA
		$-40^\circ\text{C} \leq T_A \leq +85^\circ\text{C}$		0.05	1	pA
		$-40^\circ\text{C} \leq T_A \leq +125^\circ\text{C}$				25
Input Voltage Range		$-40^\circ\text{C} \leq T_A \leq +125^\circ\text{C}$	0		5	V
Common-Mode Rejection Ratio	CMRR	$0\text{ V} \leq V_{CM} \leq 5\text{ V}$	90	105		dB
		$-40^\circ\text{C} \leq T_A \leq +85^\circ\text{C}$	90			dB
		$-40^\circ\text{C} \leq T_A \leq +125^\circ\text{C}$	85			dB
Large Signal Voltage Gain	$A_{VO}$	$0.05\text{ V} \leq V_{OUT} \leq 4.95\text{ V}$	105	120		dB
		$-40^\circ\text{C} \leq T_A \leq +125^\circ\text{C}$	100			dB
Offset Voltage Drift	$\Delta V_{OS}/\Delta T$	$-40^\circ\text{C} \leq T_A \leq +125^\circ\text{C}$		2		$\mu\text{V}/^\circ\text{C}$
Input Resistance	$R_{IN}$			220		$\text{G}\Omega$
Input Capacitance Differential Mode	$C_{IN(DM)}$			2.5		pF
Input Capacitance Common Mode	$C_{IN(CM)}$			4.7		pF
<b>OUTPUT CHARACTERISTICS</b>						
Output Voltage High	$V_{OH}$	$R_L = 100\text{ k}\Omega$ to GND	4.98	4.99		V
		$-40^\circ\text{C} \leq T_A \leq +125^\circ\text{C}$	4.98			V
		$R_L = 10\text{ k}\Omega$ to GND	4.9	4.95		V
		$-40^\circ\text{C} \leq T_A \leq +125^\circ\text{C}$	4.9			V
Output Voltage Low	$V_{OL}$	$R_L = 100\text{ k}\Omega$ to $V_{SY}$		2	5	mV
		$-40^\circ\text{C} \leq T_A \leq +125^\circ\text{C}$			5	mV
		$R_L = 10\text{ k}\Omega$ to $V_{SY}$		10	25	mV
		$-40^\circ\text{C} \leq T_A \leq +125^\circ\text{C}$			25	mV
Short-Circuit Limit	$I_{SC}$	$V_{OUT} = V_{SY}$ or GND		$\pm 40$		mA
<b>POWER SUPPLY</b>						
Power Supply Rejection Ratio	PSRR	$V_{SY} = 1.8\text{ V}$ to $5\text{ V}$	100	110		dB
		$-40^\circ\text{C} \leq T_A \leq +85^\circ\text{C}$	100			dB
		$-40^\circ\text{C} \leq T_A \leq +125^\circ\text{C}$	95			dB
Supply Current per Amplifier	$I_{SY}$	$V_{OUT} = V_{SY}/2$ $-40^\circ\text{C} \leq T_A \leq +125^\circ\text{C}$		7	10	$\mu\text{A}$
					15	$\mu\text{A}$
<b>DYNAMIC PERFORMANCE</b>						
Slew Rate	SR	$R_L = 100\text{ k}\Omega$ , $C_L = 20\text{ pF}$ , $G = 1$		6		$\text{mV}/\mu\text{s}$
Gain Bandwidth Product	GBP	$R_L = 1\text{ M}\Omega$ , $C_L = 20\text{ pF}$ , $G = 1$		50		kHz
Phase Margin	$\Phi_M$	$R_L = 1\text{ M}\Omega$ , $C_L = 20\text{ pF}$ , $G = 1$		52		Degrees
<b>NOISE PERFORMANCE</b>						
Voltage Noise	$e_n$ p-p	$f = 0.1\text{ Hz}$ to $10\text{ Hz}$		2.95		$\mu\text{V}$ p-p
Voltage Noise Density	$e_n$	$f = 1\text{ kHz}$		55		$\text{nV}/\sqrt{\text{Hz}}$
Current Noise Density	$i_n$	$f = 1\text{ kHz}$		20		$\text{fA}/\sqrt{\text{Hz}}$

# ADA4505-2

## ELECTRICAL CHARACTERISTICS—1.8 V OPERATION

$V_{SY} = 1.8 \text{ V}$ ,  $V_{CM} = V_{SY}/2$ ,  $T_A = 25^\circ\text{C}$ , unless otherwise specified.

Table 2.

Parameter	Symbol	Conditions	Min	Typ	Max	Unit
<b>INPUT CHARACTERISTICS</b>						
Offset Voltage	$V_{OS}$	$0 \text{ V} \leq V_{CM} \leq 1.8 \text{ V}$ $-40^\circ\text{C} \leq T_A \leq +125^\circ\text{C}$		0.5	2.5	mV
Input Bias Current	$I_B$	$-40^\circ\text{C} \leq T_A \leq +85^\circ\text{C}$ $-40^\circ\text{C} \leq T_A \leq +125^\circ\text{C}$		0.5	3	mV
					2	300
Input Offset Current	$I_{OS}$	$-40^\circ\text{C} \leq T_A \leq +85^\circ\text{C}$ $-40^\circ\text{C} \leq T_A \leq +125^\circ\text{C}$		0.05	1	pA
					25	50
Input Voltage Range		$-40^\circ\text{C} \leq T_A \leq +125^\circ\text{C}$	0		1.8	V
Common-Mode Rejection Ratio	CMRR	$0 \text{ V} \leq V_{CM} \leq 1.8 \text{ V}$	85	100		dB
		$-40^\circ\text{C} \leq T_A \leq +85^\circ\text{C}$	85			dB
		$-40^\circ\text{C} \leq T_A \leq +125^\circ\text{C}$	80			dB
Large Signal Voltage Gain	$A_{VO}$	$0.05 \text{ V} \leq V_{OUT} \leq 1.75 \text{ V}$	95	115		dB
		$-40^\circ\text{C} \leq T_A \leq +125^\circ\text{C}$	95			dB
Offset Voltage Drift	$\Delta V_{OS}/\Delta T$	$-40^\circ\text{C} \leq T_A \leq +125^\circ\text{C}$		2.5		$\mu\text{V}/^\circ\text{C}$
Input Resistance	$R_{IN}$			220		G $\Omega$
Input Capacitance Differential Mode	$C_{INDM}$			2.5		pF
Input Capacitance Common Mode	$C_{INCM}$			4.7		pF
<b>OUTPUT CHARACTERISTICS</b>						
Output Voltage High	$V_{OH}$	$R_L = 100 \text{ k}\Omega$ to GND	1.78	1.79		V
		$-40^\circ\text{C} \leq T_A \leq +125^\circ\text{C}$	1.78			V
		$R_L = 10 \text{ k}\Omega$ to GND	1.65	1.75		V
		$-40^\circ\text{C} \leq T_A \leq +125^\circ\text{C}$	1.65			V
Output Voltage Low	$V_{OL}$	$R_L = 100 \text{ k}\Omega$ to $V_{SY}$		2	5	mV
		$-40^\circ\text{C} \leq T_A \leq +125^\circ\text{C}$			5	mV
		$R_L = 10 \text{ k}\Omega$ to $V_{SY}$		12	25	mV
		$-40^\circ\text{C} \leq T_A \leq +125^\circ\text{C}$			25	mV
Short-Circuit Limit	$I_{SC}$	$V_{OUT} = V_{SY}$ or GND		$\pm 3.8$		mA
<b>POWER SUPPLY</b>						
Power Supply Rejection Ratio	PSRR	$V_{SY} = 1.8 \text{ V}$ to 5 V	100	110		dB
		$-40^\circ\text{C} \leq T_A \leq +85^\circ\text{C}$	100			dB
		$-40^\circ\text{C} \leq T_A \leq +125^\circ\text{C}$	95			dB
Supply Current per Amplifier	$I_{SY}$	$V_{OUT} = V_{SY}/2$		7	10	$\mu\text{A}$
		$-40^\circ\text{C} \leq T_A \leq +125^\circ\text{C}$			15	$\mu\text{A}$
<b>DYNAMIC PERFORMANCE</b>						
Slew Rate	SR	$R_L = 100 \text{ k}\Omega$ , $C_L = 20 \text{ pF}$ , $G = 1$		6.5		mV/ $\mu\text{s}$
Gain Bandwidth Product	GBP	$R_L = 1 \text{ M}\Omega$ , $C_L = 20 \text{ pF}$ , $G = 1$		50		kHz
Phase Margin	$\Phi_M$	$R_L = 1 \text{ M}\Omega$ , $C_L = 20 \text{ pF}$ , $G = 1$		52		Degrees
<b>NOISE PERFORMANCE</b>						
Voltage Noise	$e_n$ p-p	$f = 0.1 \text{ Hz}$ to 10 Hz		2.95		$\mu\text{V}$ p-p
Voltage Noise Density	$e_n$	$f = 1 \text{ kHz}$		55		nV/ $\sqrt{\text{Hz}}$
Current Noise Density	$i_n$	$f = 1 \text{ kHz}$		20		fA/ $\sqrt{\text{Hz}}$

## ABSOLUTE MAXIMUM RATINGS

Table 3.

Parameter	Rating
Supply Voltage	5.5 V
Input Voltage	$\pm V_{SY} \pm 0.1$ V
Input Current <sup>1</sup>	$\pm 10$ mA
Differential Input Voltage <sup>2</sup>	$\pm V_{SY}$
Output Short-Circuit Duration to GND	Indefinite
Storage Temperature Range	-65°C to +150°C
Operating Temperature Range	-40°C to +125°C
Junction Temperature Range	-65°C to +150°C
Lead Temperature (Soldering, 60 sec)	300°C

<sup>1</sup> Input pins have clamp diodes to the supply pins. Input current should be limited to 10 mA or less whenever the input signal exceeds the power supply rail by 0.5 V.

<sup>2</sup> Differential input voltage is limited to 5 V or the supply voltage, whichever is less.

Stresses above those listed under Absolute Maximum Ratings may cause permanent damage to the device. This is a stress rating only; functional operation of the device at these or any other conditions above those indicated in the operational section of this specification is not implied. Exposure to absolute maximum rating conditions for extended periods may affect device reliability.

## THERMAL RESISTANCE

$\theta_{JA}$  is specified for the worst-case conditions, that is, a device soldered in a circuit board for surface-mount packages. This was measured using a standard two-layer board.

Table 4. Thermal Resistance

Package Type	$\theta_{JA}$	$\theta_{JC}$	Unit
8-Lead MSOP (RM-8)	206	44	°C/W

## ESD CAUTION



**ESD (electrostatic discharge) sensitive device.** Charged devices and circuit boards can discharge without detection. Although this product features patented or proprietary protection circuitry, damage may occur on devices subjected to high energy ESD. Therefore, proper ESD precautions should be taken to avoid performance degradation or loss of functionality.

## TYPICAL PERFORMANCE CHARACTERISTICS

$T_A = 25^\circ\text{C}$ , unless otherwise noted.

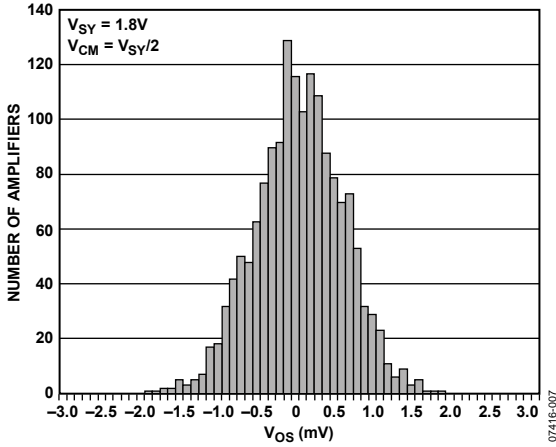

Figure 2. Input Offset Voltage Distribution

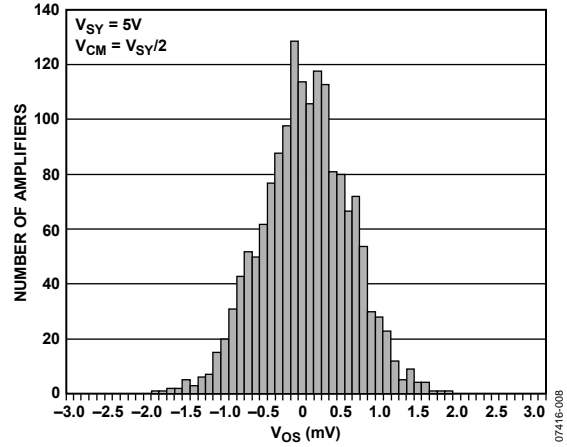

Figure 5. Input Offset Voltage Distribution

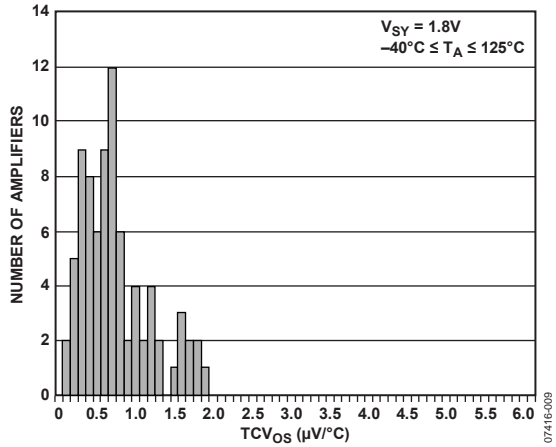

Figure 3. Input Offset Voltage Drift Distribution

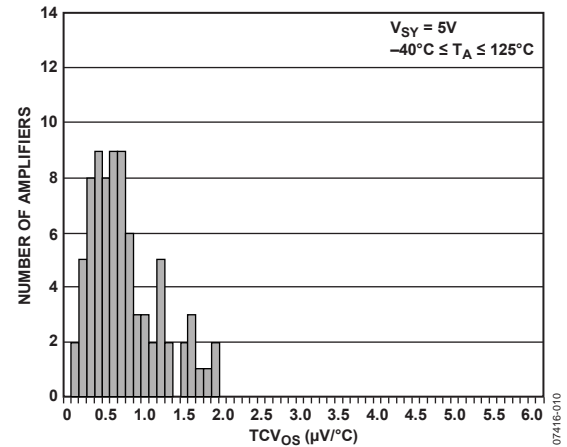

Figure 6. Input Offset Voltage Drift Distribution

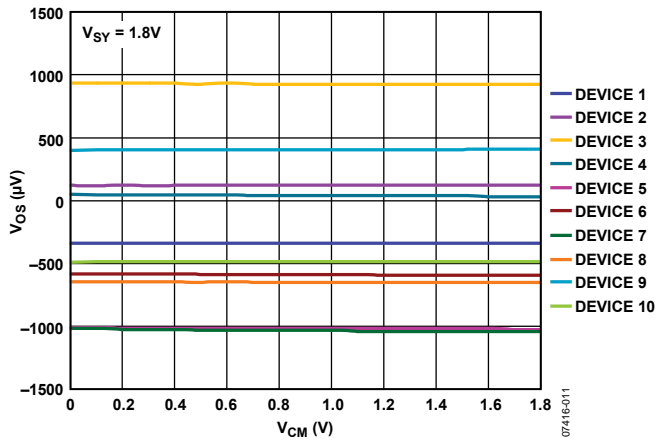

Figure 4. Input Offset Voltage vs. Common-Mode Voltage

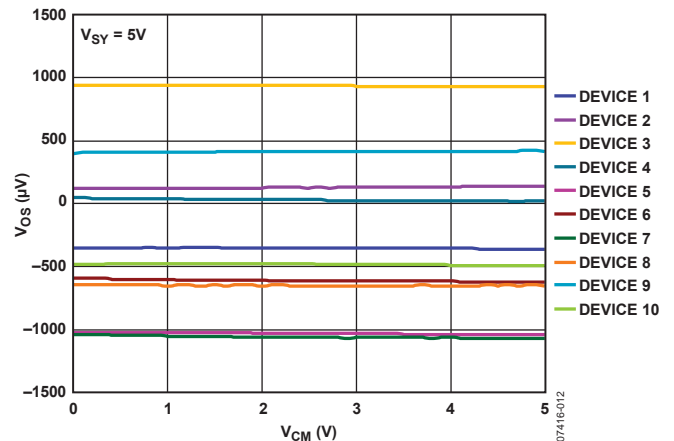

Figure 7. Input Offset Voltage vs. Common-Mode Voltage

T<sub>A</sub> = 25°C, unless otherwise noted.

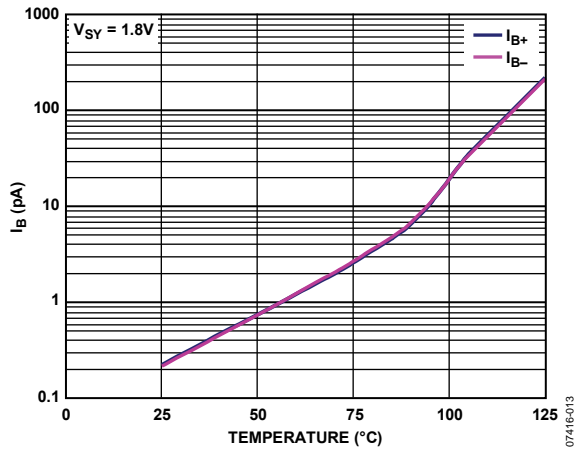

Figure 8. Input Bias Current vs. Temperature

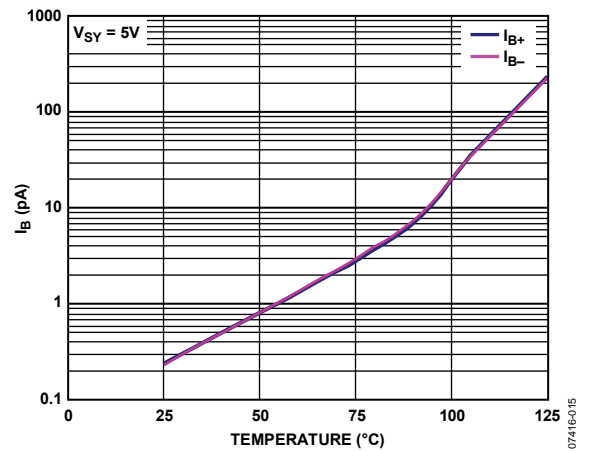

Figure 11. Input Bias Current vs. Temperature

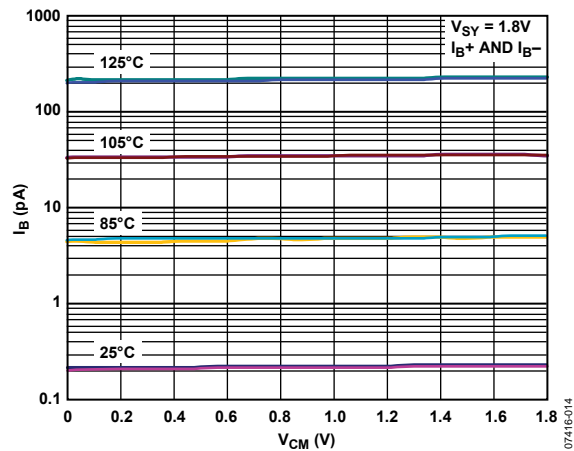

Figure 9. Input Bias Current vs. Common-Mode Voltage

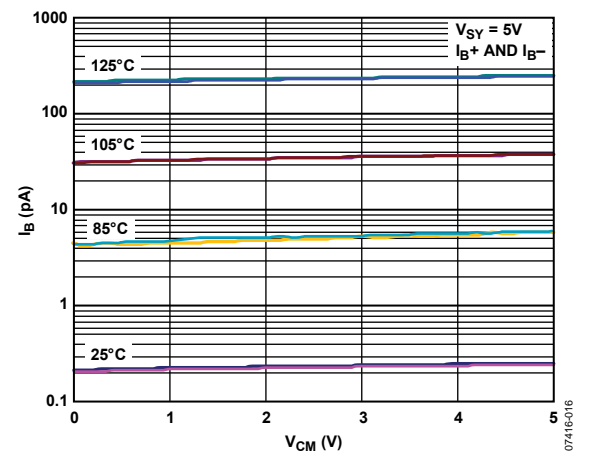

Figure 12. Input Bias Current vs. Common-Mode Voltage

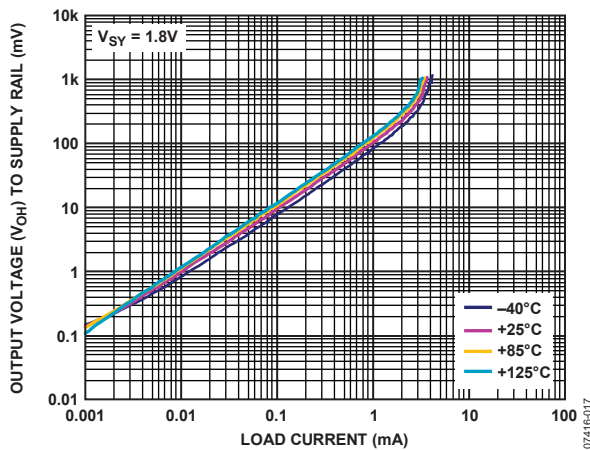

Figure 10. Output Voltage (V<sub>OH</sub>) to Supply Rail vs. Load Current and Temperature

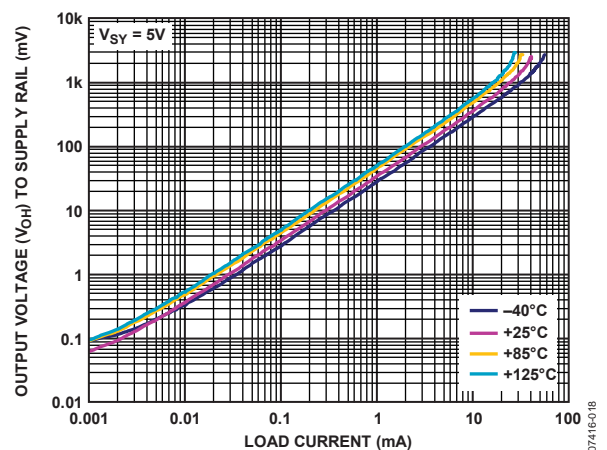

Figure 13. Output Voltage (V<sub>OH</sub>) to Supply Rail vs. Load Current and Temperature

# ADA4505-2

$T_A = 25^\circ\text{C}$ , unless otherwise noted.

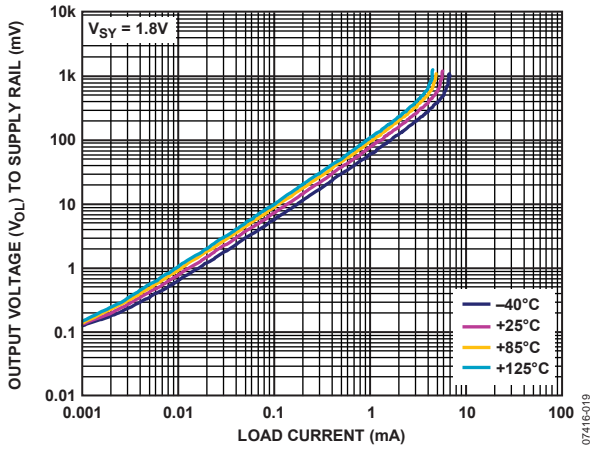

Figure 14. Output Voltage ( $V_{OL}$ ) to Supply Rail vs. Load Current and Temperature

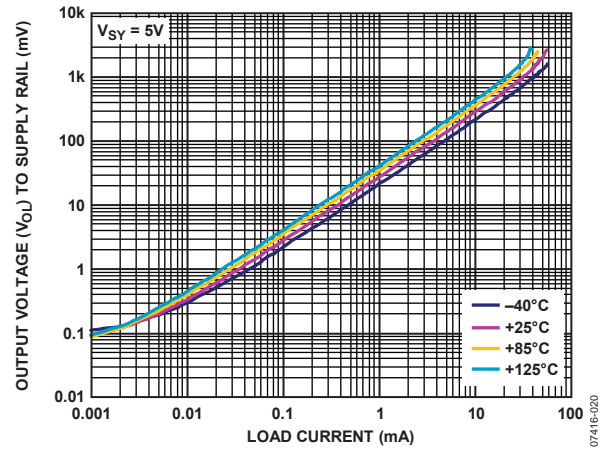

Figure 17. Output Voltage ( $V_{OL}$ ) to Supply Rail vs. Load Current and Temperature

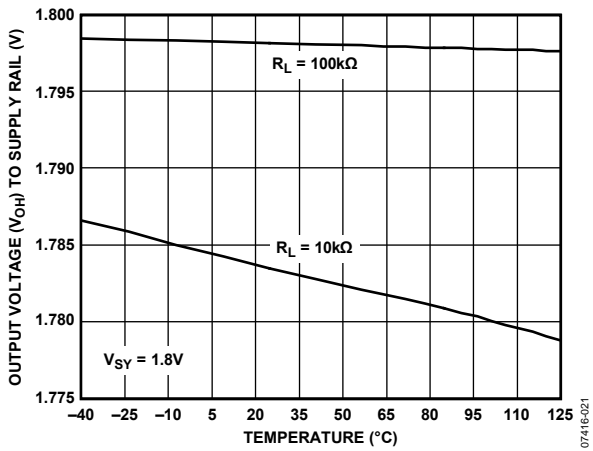

Figure 15. Output Voltage ( $V_{OH}$ ) to Supply Rail vs. Temperature

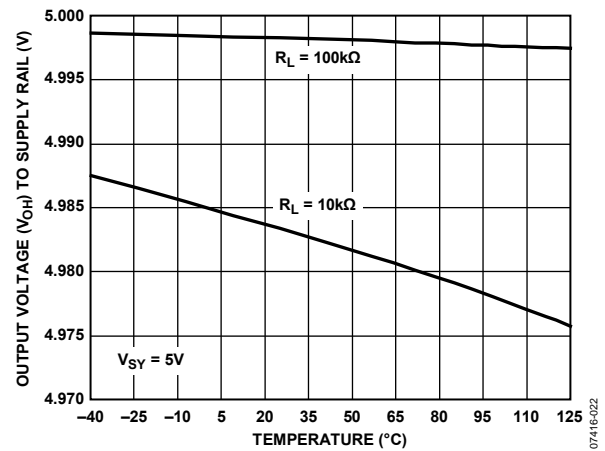

Figure 18. Output Voltage ( $V_{OH}$ ) to Supply Rail vs. Temperature

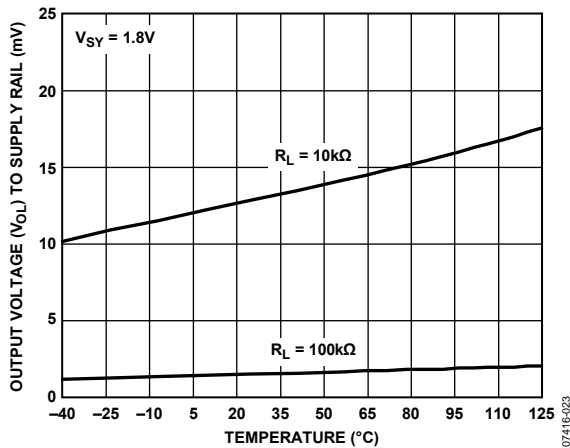

Figure 16. Output Voltage ( $V_{OI}$ ) to Supply Rail vs. Temperature

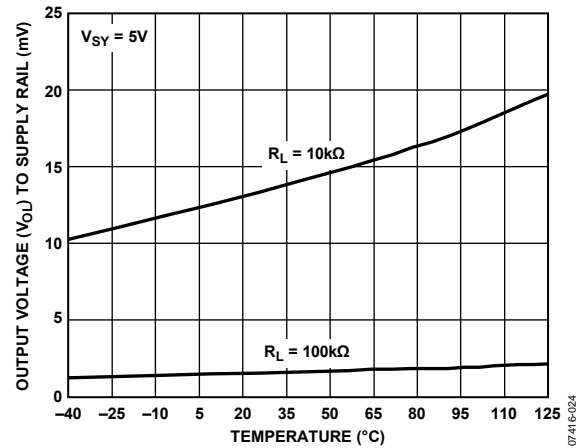

Figure 19. Output Voltage ( $V_{OI}$ ) to Supply Rail vs. Temperature



T<sub>A</sub> = 25°C, unless otherwise noted.

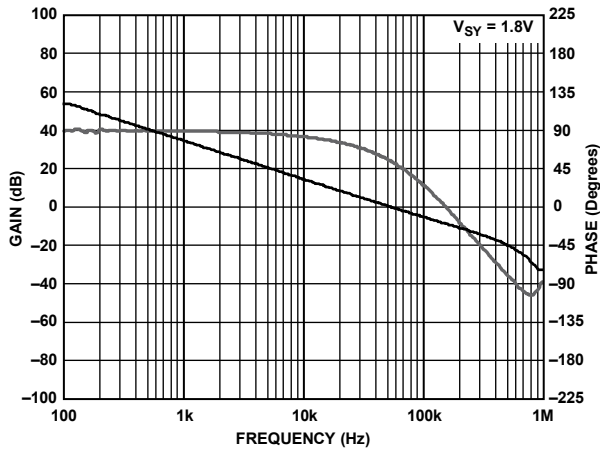

Figure 20. Open-Loop Gain and Phase vs. Frequency

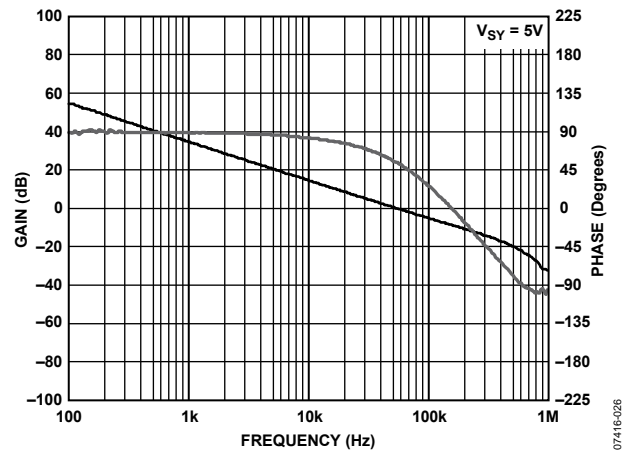

Figure 23. Open-Loop Gain and Phase vs. Frequency

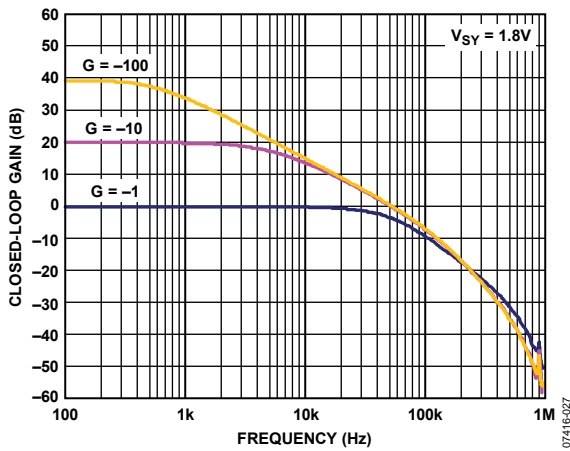

Figure 21. Closed-Loop Gain vs. Frequency..

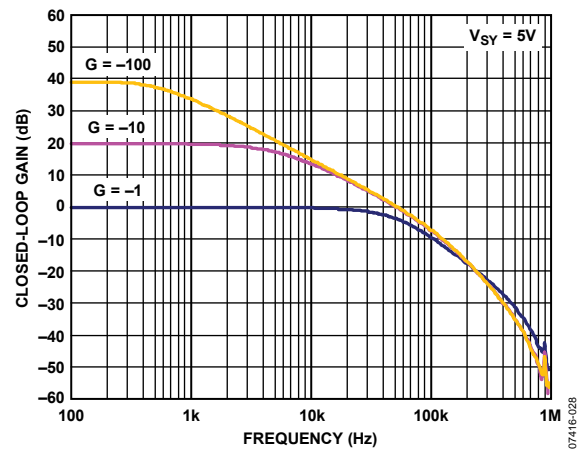

Figure 24. Closed-Loop Gain vs. Frequency

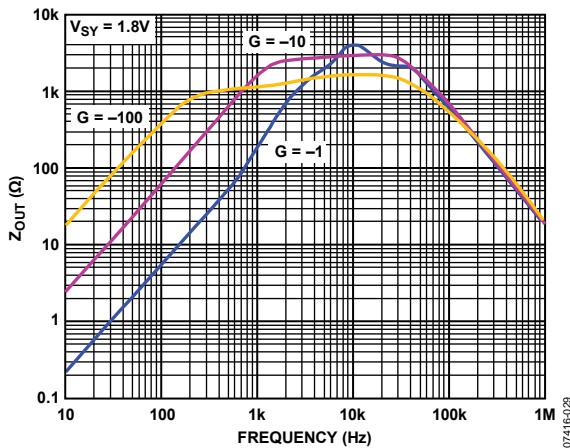

Figure 22. Output Impedance vs. Frequency

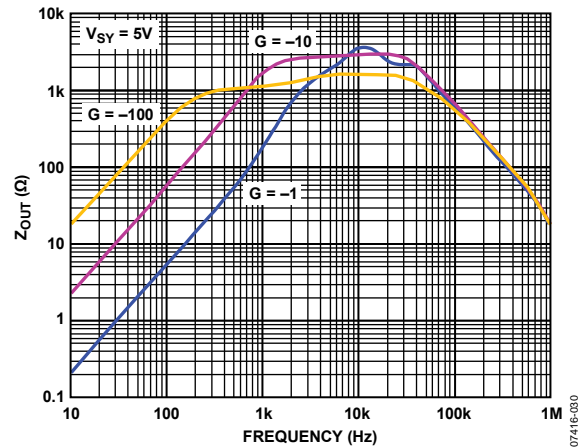

Figure 25. Output Impedance vs. Frequency

# ADA4505-2

$T_A = 25^\circ\text{C}$ , unless otherwise noted.

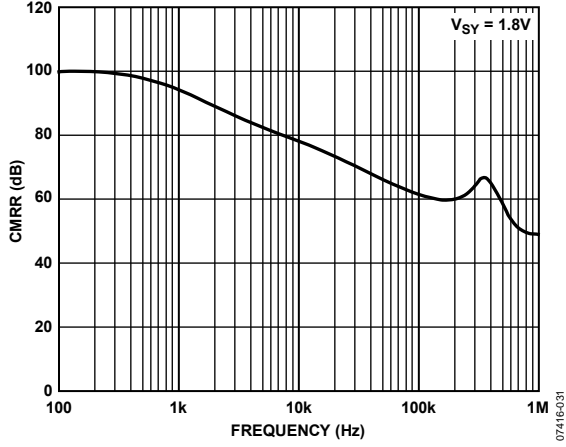

Figure 26. CMRR vs. Frequency

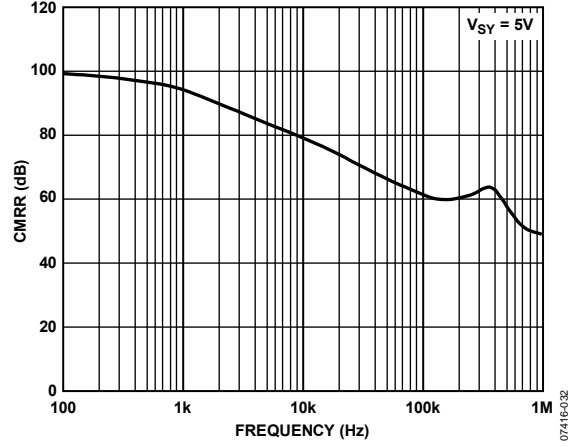

Figure 29. CMRR vs. Frequency

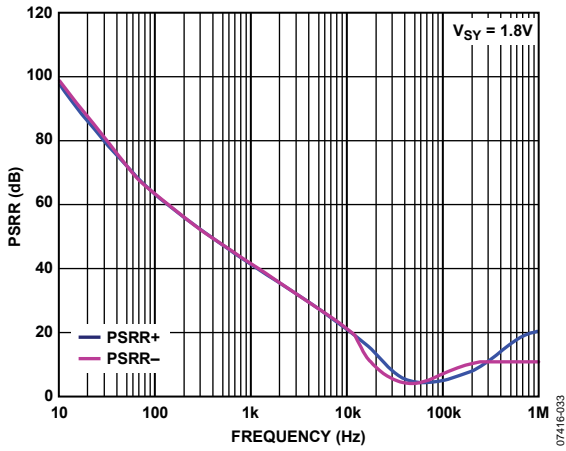

Figure 27. PSRR vs. Frequency

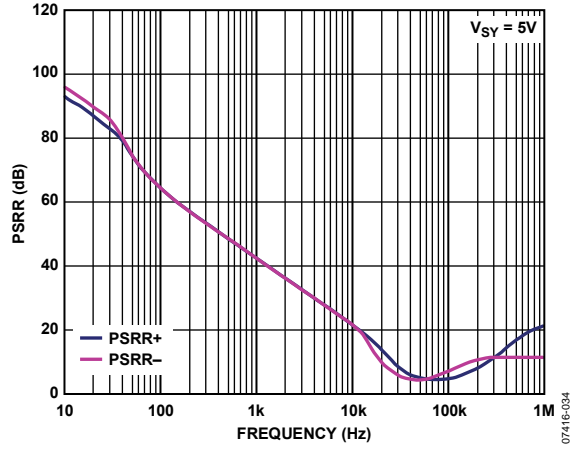

Figure 30. PSRR vs. Frequency

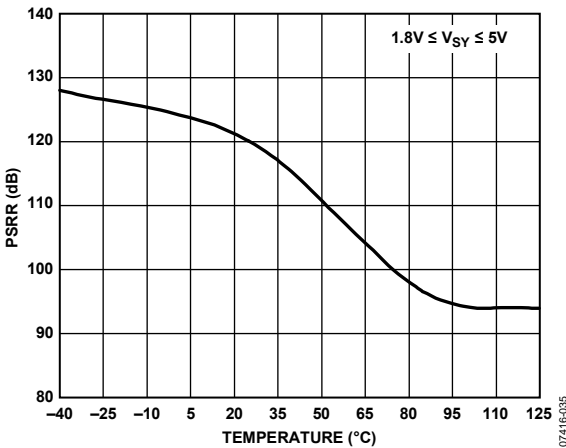

Figure 28. PSRR vs. Temperature

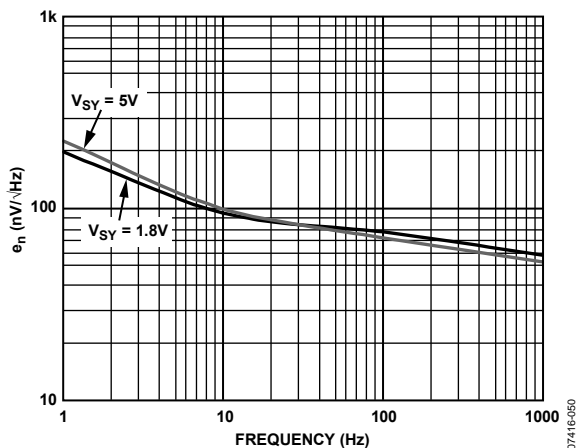

Figure 31. Voltage Noise Density vs. Frequency

T<sub>A</sub> = 25°C, unless otherwise noted.

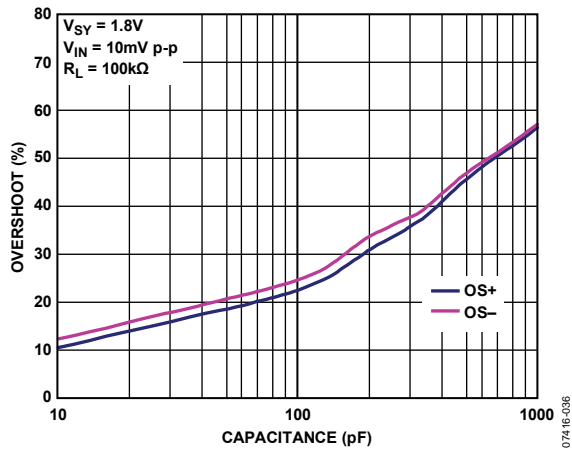

Figure 32. Small Signal Overshoot vs. Load Capacitance

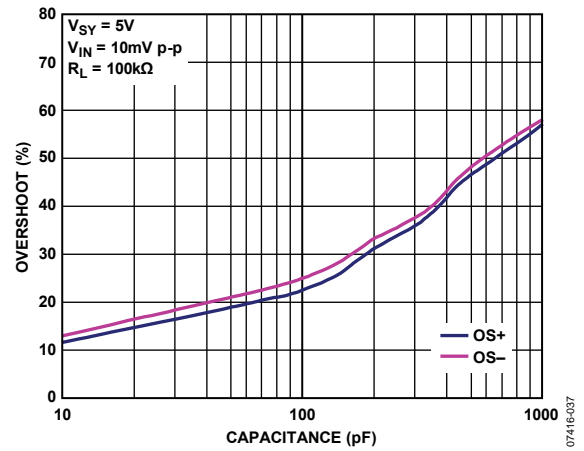

Figure 35. Small Signal Overshoot vs. Load Capacitance

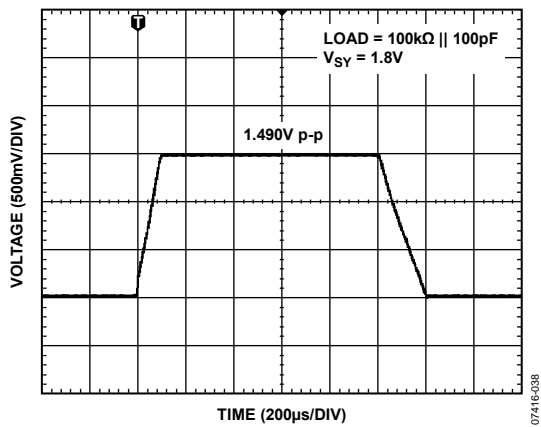

Figure 33. Large Signal Transient Response

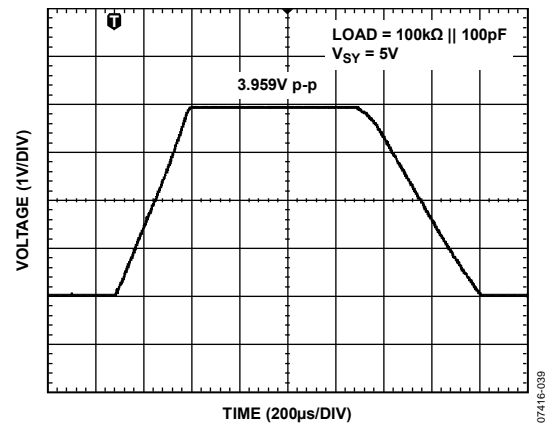

Figure 36. Large Signal Transient Response

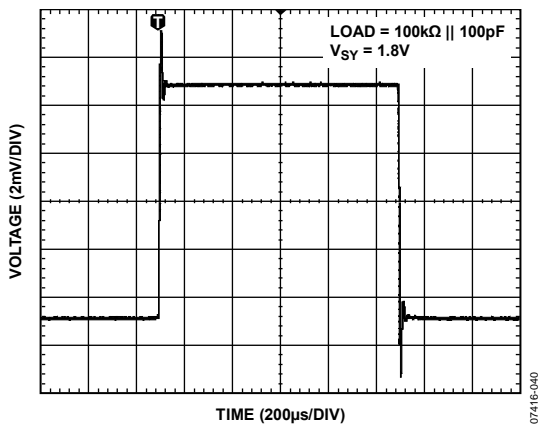

Figure 34. Small Signal Transient Response

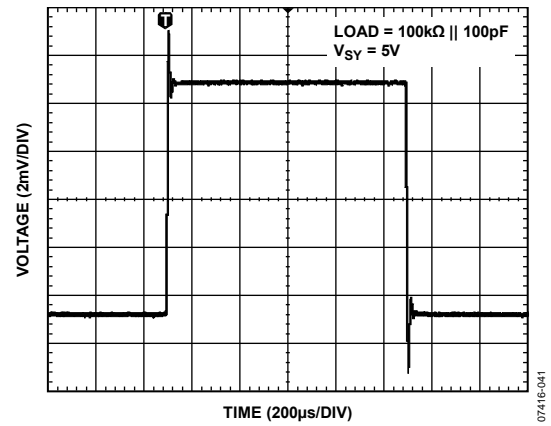

Figure 37. Small Signal Transient Response

# ADA4505-2

$T_A = 25^\circ\text{C}$ , unless otherwise noted.

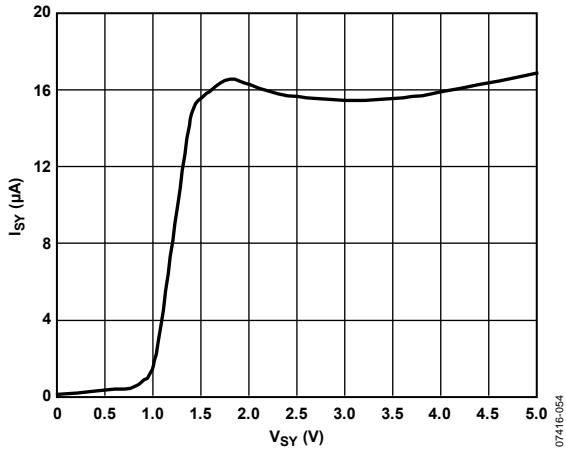

Figure 38. Supply Current vs. Supply Voltage

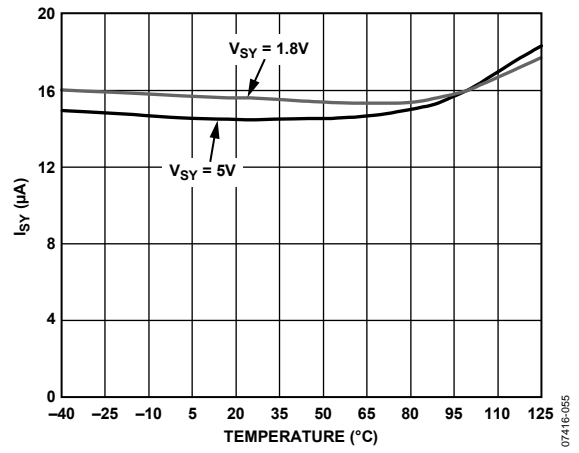

Figure 41. Total Supply Current vs. Temperature

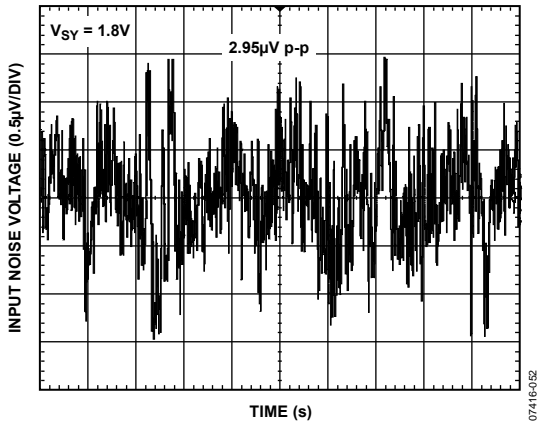

Figure 39. 0.1 Hz to 10 Hz Noise

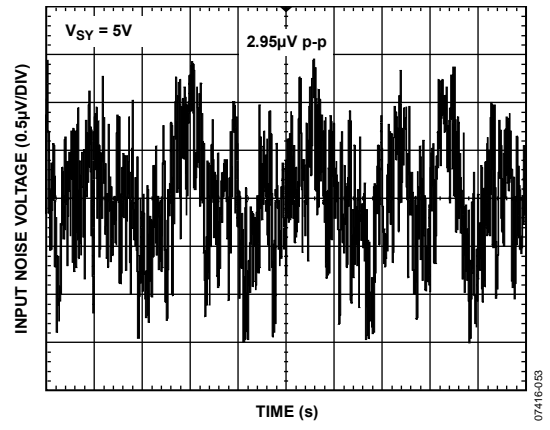

Figure 42. 0.1 Hz to 10 Hz Noise

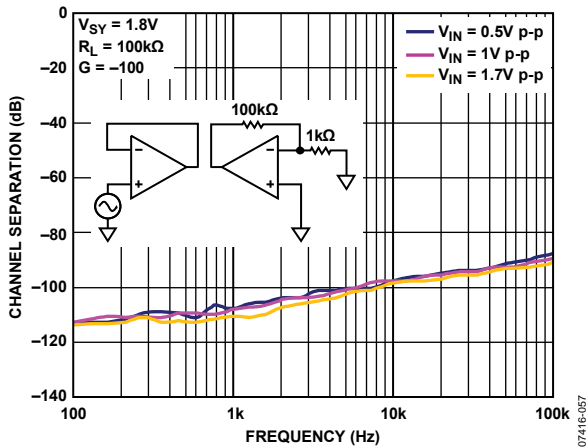

Figure 40. Channel Separation vs. Frequency

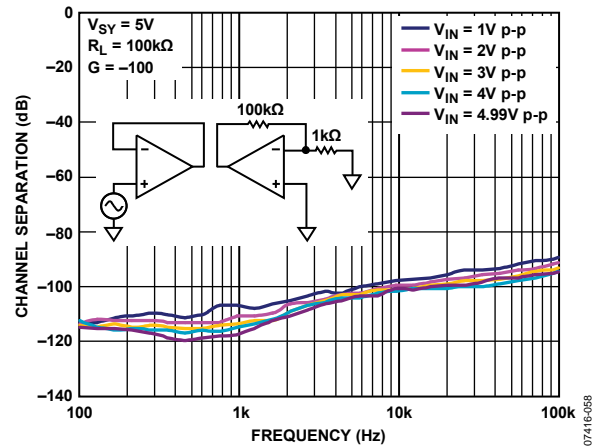

Figure 43. Channel Separation vs. Frequency

T<sub>A</sub> = 25°C, unless otherwise noted.

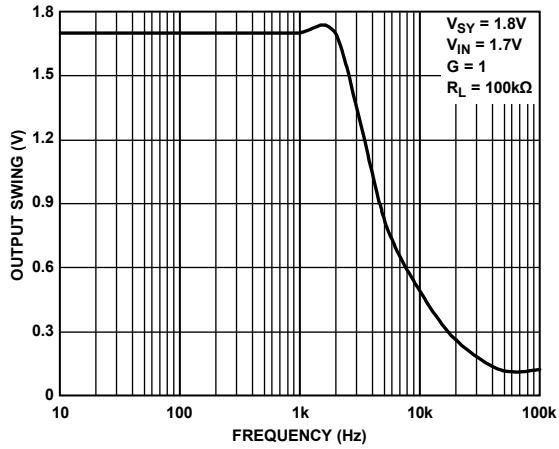

Figure 44. Output Swing vs. Frequency

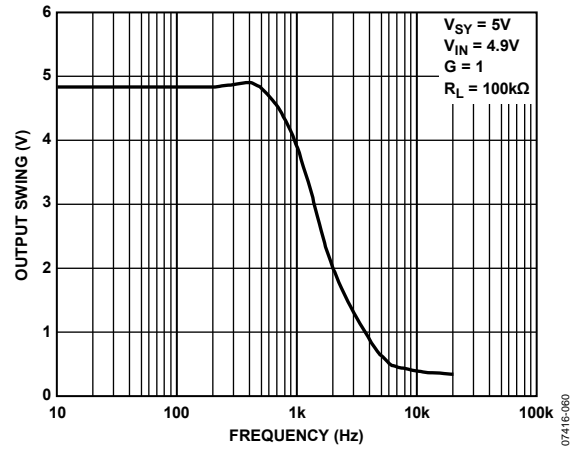

Figure 46. Output Swing vs. Frequency

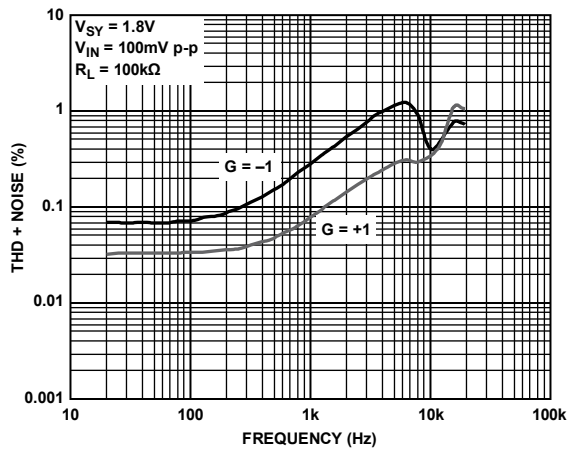

Figure 45. THD + Noise vs. Frequency

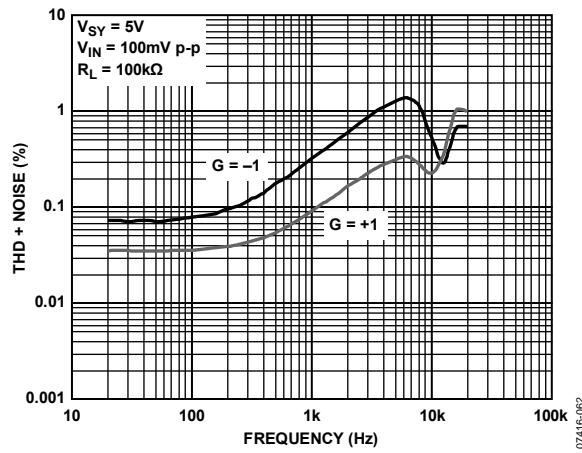

Figure 47. THD + Noise vs. Frequency

## THEORY OF OPERATION

The ADA4505-2 is a unity-gain stable CMOS rail-to-rail input/output operational amplifier designed to optimize performance in current consumption, PSRR, CMRR, and zero crossover distortion, all imbedded in a small package. The typical offset voltage is 500  $\mu\text{V}$ , with a low peak-to-peak voltage noise of 2.95  $\mu\text{V}$  p-p from 0.1 Hz to 10 Hz and a voltage noise density of 55  $\text{nV}/\sqrt{\text{Hz}}$  at 1 kHz.

The ADA4505-2 was designed to solve two key problems in low voltage battery-powered applications: battery voltage decrease over time and rail-to-rail input stage distortion.

In battery-powered applications, the supply voltage available to the IC is the voltage of the battery. Unfortunately, the voltage of a battery decreases as it discharges itself through the load. This voltage drop over the lifetime of the battery causes an error in the output of the op amps. Some applications requiring precision measurements during the entire lifetime of the battery use voltage regulators to power up the op amps as a solution. If a design uses standard battery cells, the op amps experience a supply voltage change from roughly 3.2 V to 1.8 V during the lifetime of the battery. This means that for a PSRR of 70 dB minimum in a typical op amp, the input-referred offset error is approximately 440  $\mu\text{V}$ . If the same application uses the ADA4505-2 with a 100 dB minimum PSRR, the error is only 14  $\mu\text{V}$ . It is possible to calibrate out this error or to use an external voltage regulator to power the op amp, but these solutions can increase system cost and complexity. The ADA4505-2 solves the impasse with no additional cost or error-nullifying circuitry.

The second problem with battery-powered applications is the distortion caused by the standard rail-to-rail input stage. Using a CMOS non-rail-to-rail input stage (that is, a single differential pair) limits the input voltage to approximately one  $V_{GS}$  (gate-source voltage) away from one of the supply lines. Because  $V_{GS}$  for normal operation is commonly over 1 V, a single differential pair input stage op amp greatly restricts the allowable input voltage range when using a low supply voltage. This limitation restricts the number of applications where the non-rail-to-rail input op amp was originally intended to be used. To solve this problem, a dual differential pair input stage is usually implemented (see Figure 48); however, this technique has its own drawbacks.

One differential pair amplifies the input signal when the common-mode voltage is on the high end, whereas the other pair amplifies the input signal when the common-mode voltage is on the low end. This method also requires a control circuitry to operate the two differential pairs appropriately. Unfortunately, this topology leads to a very noticeable and undesirable problem: if the signal level moves through the range where one input stage turns off and the other one turns on, noticeable distortion occurs (see Figure 49).

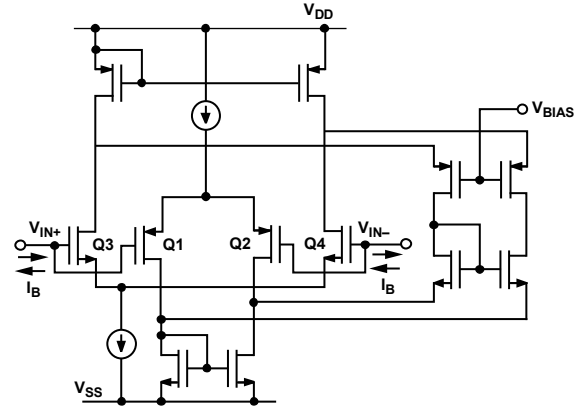

Figure 48. A Typical Dual Differential Pair Input Stage Op Amp (Dual PMOS Q1 and Q2 Transistors Form the Lower End of the Input Voltage Range Whereas Dual NMOS Q3 and Q4 Compose the Upper End)

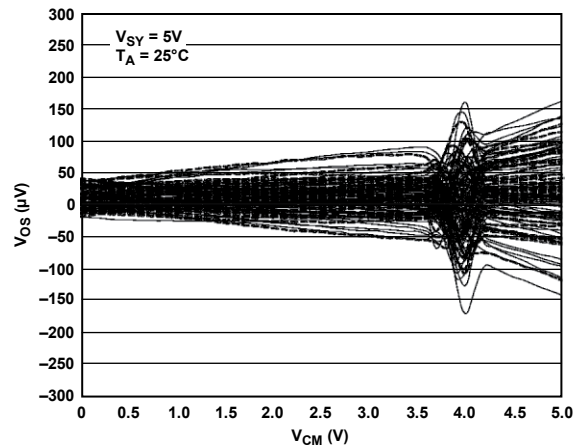

Figure 49. Typical Input Offset Voltage vs. Common-Mode Voltage Response in a Dual Differential Pair Input Stage Op Amp (Powered by 5 V Supply; Results of Approximately 100 Units per Graph Are Displayed)

This distortion forces the designer to come up with impractical ways to avoid the crossover distortion areas, therefore narrowing the common-mode dynamic range of the operational amplifier. The ADA4505-2 solves this crossover distortion problem by using an on-chip charge pump to power the input differential pair. The charge pump creates a supply voltage higher than the voltage of the battery, allowing the input stage to handle a wide range of input signal voltages without using a second differential pair. With this solution, the input voltage can vary from one supply extreme to the other with no distortion, thereby restoring the op amp full common-mode dynamic range.

The charge pump has been carefully designed so that switching noise components at any frequency, both within and beyond the amplifier bandwidth, are much lower than the thermal noise floor. Therefore, the spurious-free dynamic range (SFDR) is limited only by the input signal and the thermal or flicker noise. There is no intermodulation between input signal and switching noise.

Figure 50 displays a typical front-end section of an operational amplifier with an on-chip charge pump.

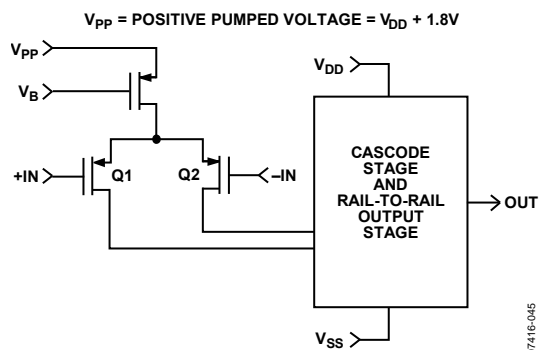

Figure 50. Typical Front-End Section of an Op Amp with Embedded Charge Pump

Figure 51, input offset voltage vs. input common-mode voltage response, shows the typical response of two devices from Figure 7. Figure 51 has been expanded so that it is easier to compare with Figure 49, typical input offset voltage vs. common-mode voltage response in a dual differential pair input stage op amp.

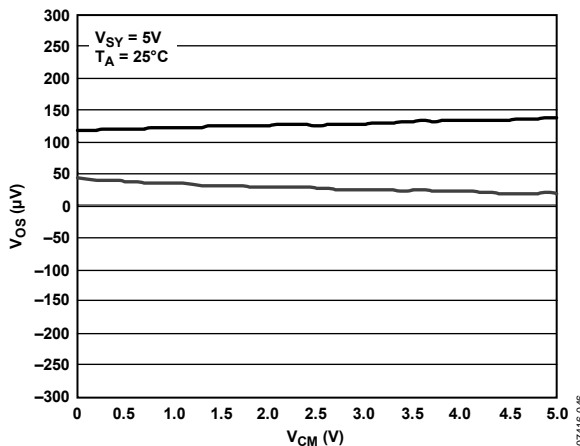

Figure 51. Input Offset Voltage vs. Input Common-Mode Voltage Response (Powered by a 5 V Supply; Results of Two Units Are Displayed)

This solution improves the CMRR performance tremendously. For instance, if the input varies from rail-to-rail on a 2.5 V supply rail, using a part with a CMRR of 70 dB minimum, an input-referred error of 790  $\mu$ V is introduced. Another part with a CMRR of 52 dB minimum generates a 6.3 mV error. The ADA4505-2 CMRR of 90 dB minimum causes only a 79  $\mu$ V error. As with the PSRR error, there are complex ways to minimize this error, but the ADA4505-2 solves this problem without incurring unnecessary circuitry complexity or increased cost.

## APPLICATIONS INFORMATION

### PULSE OXIMETER CURRENT SOURCE

A pulse oximeter is a noninvasive medical device used for measuring continuously the percentage of hemoglobin (Hb) saturated with oxygen and the pulse rate of a patient. Hemoglobin that is carrying oxygen (oxyhemoglobin) absorbs light in the infrared (IR) region of the spectrum; hemoglobin that is not carrying oxygen (deoxyhemoglobin) absorbs visible red (R) light. In pulse oximetry, a clip containing two LEDs (sometimes more, depending on the complexity of the measurement algorithm) and the light sensor (photodiode) is placed on the finger or earlobe of the patient. One LED emits red light (600 nm to 700 nm) and the other emits light in the near IR (800 nm to 900 nm) region. The clip is connected by a cable to a processor unit. The LEDs are rapidly and sequentially excited by two current sources (one for each LED), whose dc levels depend on the LED being driven, based on manufacturer requirements, and the detector is synchronized to capture the light from each LED as it is transmitted through the tissue.

An example design of a dc current source driving the red and infrared LEDs is shown in Figure 52. These dc current sources allow 62.5 mA and 101 mA to flow through the red and infrared LEDs, respectively. First, to prolong battery life, the LEDs are driven only when needed. One-third of the ADG733 SPDT analog switch is used to disconnect/connect the 1.25 V voltage reference from/to each current circuit. When driving the LEDs, the ADR1581 1.25 V voltage reference is buffered by 1/2 of the ADA4505-2; the presence of this voltage on the noninverting input forces the output of the op amp (due to the negative feedback) to maintain a level that makes its inverting input-to-track the noninverting pin. Therefore, the 1.25 V appears in parallel with the 20 Ω R1 or 12.4 Ω R5 current source resistor, creating the flow of the 62.5 mA or 101 mA current through the red or infrared LED as the output of the op amp turns on the Q1 or Q2 N-MOSFET IRLMS2002.

The maximum total quiescent currents for the 1/2 ADA4505-2, ADR1581, and ADG733 are 15 μA, 70 μA, and 1 μA, respectively, making a total of 86 μA current consumption (430 μW power consumption) per circuit, which is good for a system powered by a battery. If the accuracy and temperature drift of the total design need to be improved, then a more accurate and low temperature coefficient drift voltage reference and current source resistor should be utilized. C3 and C4 are used to improve stabilization of U1; R3 and R7 are used to provide some current limit into the U1 inverting pin; and R2 and R6 are used to slow down the rise time of the N-MOSFET when it turns on. These elements may not be needed, or some bench adjustments may be required.

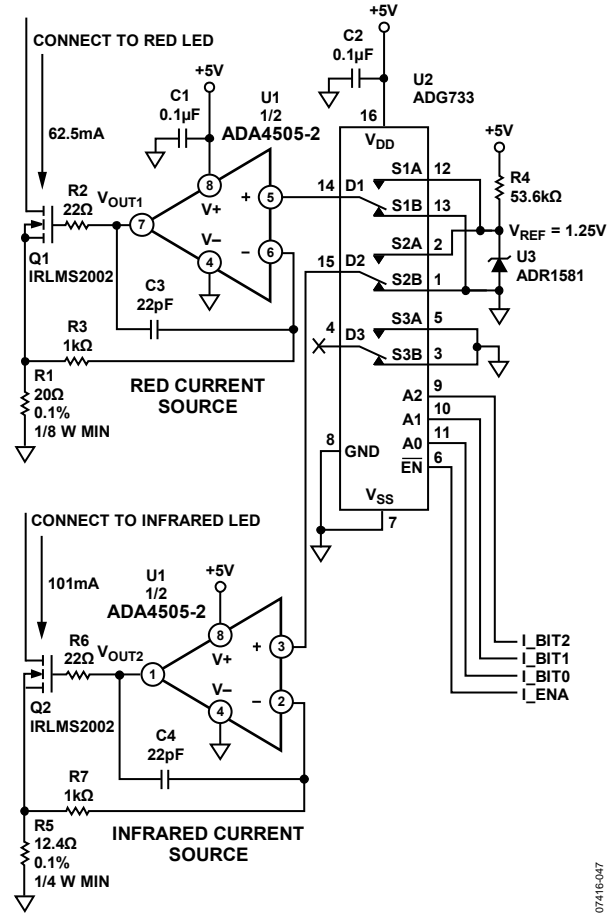

Figure 52. Pulse Oximeter Red and Infrared Current Sources Using the ADA4505-2 as a Buffer to the Voltage Reference Device

07416-047



### FOUR-POLE LOW-PASS BUTTERWORTH FILTER FOR GLUCOSE MONITOR

There are several methods of glucose monitoring: spectroscopic absorption of infrared light in the 2  $\mu\text{m}$  to 2.5  $\mu\text{m}$  range, reflectance spectrophotometry, and the amperometric type using electrochemical strips with glucose oxidase enzymes. The amperometric type generally uses three electrodes: a reference electrode, a control electrode, and a working electrode. Although this is a very old technique and widely used, signal-to-noise ratio and repeatability can be improved using the ADA4505-2 with its low peak-to-peak voltage noise of 2.95  $\mu\text{V}$  p-p from 0.1 Hz to 10 Hz and voltage noise density of 55 nV/ $\sqrt{\text{Hz}}$  at 1 kHz.

Another consideration is operation from a 3.3 V battery. Glucose signal currents are usually less than 3  $\mu\text{A}$  full scale, so the I-to-V

converter requires low input bias current. The ADA4505-2 is an excellent choice because it provides 0.5 pA typical and 2 pA maximum of input bias current at ambient temperature.

A low-pass filter with a cutoff frequency of 80 Hz to 100 Hz is desirable in a glucose meter device to remove extraneous noise; this can be a simple two- or four-pole Butterworth. Low power op amps with bandwidths of 50 kHz to 500 kHz should be adequate. The ADA4505-2 with its 50 kHz GBP and 10  $\mu\text{A}$  typical of current consumption meets these requirements. A circuit design of a four-pole Butterworth filter (preceded by a one-pole low-pass filter) is shown in Figure 53. With a 3.3 V battery, the total power consumption of this design is 198  $\mu\text{W}$  typical at ambient temperature.

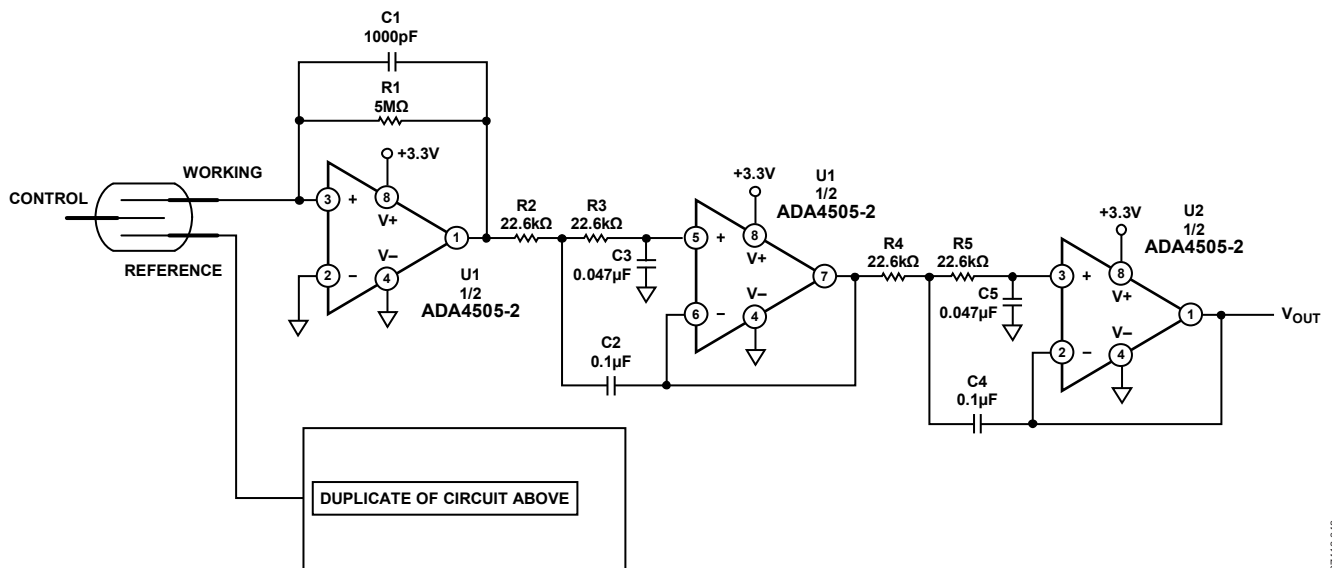
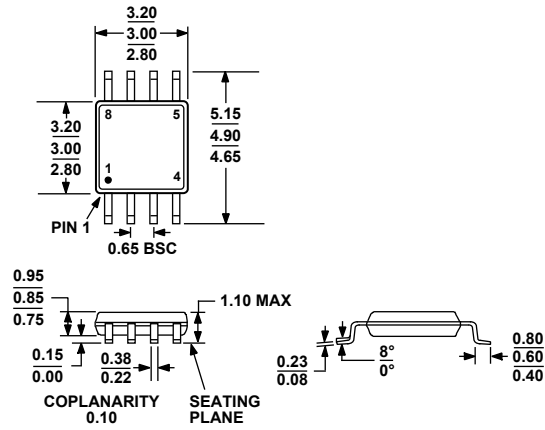

Figure 53. A Four-Pole Butterworth Filter That Can Be Used in a Glucose Meter

07416-048

## OUTLINE DIMENSIONS



COMPLIANT TO JEDEC STANDARDS MO-187-AA

Figure 54. 8-Lead Mini Small Outline Package [MSOP] (RM-8)

Dimensions shown in millimeters

## ORDERING GUIDE

Model	Temperature Range	Package Description	Package Option	Branding
ADA4505-2ARMZ-R2 <sup>1</sup>	-40°C to +125°C	8-Lead MSOP	RM-8	A21
ADA4505-2ARMZ-RL <sup>1</sup>	-40°C to +125°C	8-Lead MSOP	RM-8	A21

<sup>1</sup> Z = RoHS Compliant Part.

**NOTES**

**NOTES**